

# Trinity

Model # TR.388.80

3-Compartment Industrial Sink

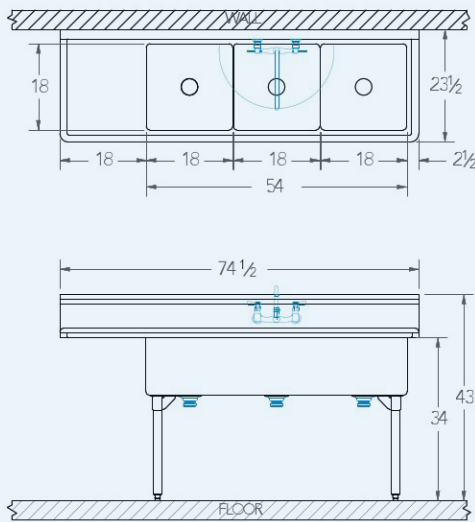

### Bowl (Lg x Wd x Dp)

18" x 18" x 12"

### Drainboard

Left: 18"

Right: -"

### Overall (Lg x Wd x Ht)

74 1/2" x 23 1/2" x 43"

### Material

14 gauge, stainless steel

### Faucet Holes

1-1/8" Dia 8" Centers

### Drain

3-1/2" Dia Opening

### Included:



Matched Faucet



Basket Drain(s)



Install Kit

### Additional Features

- 14 gauge stainless steel
- NSF approved construction
- R 3/4" coved compartments
- 12" deep compartments
- Stainless steel legs & feet
- Bi-directional gusseted leg sockets
- 9" tile-edge backsplash
- 1-1/2" sanitary rolled-rim
- D 3-1/2" recessed drain opening
- Specification grade hardware included
- 10-year warranty
- Made in Texas